

SPORTESA

pod' sa hrať...



detské ihriská
fitness
workout
výstavba multifunkčných
ihrísk, atletické dráhy,
rekonštrukcie telocviční,
osvetlenie verejných
priestranstiev



SPORTESA s.r.o
www.sportesa.sk
info@sportesa.sk



ZMENY KONFIGURÁCIE



B-1



B-3



B-4



PM-4



PM-2



B-5

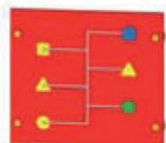

B-6



B-7



PM-5

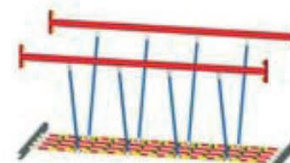

PM-7

ZÁBRADLIA

MOSTY

MODULY ZRUČNOSTI

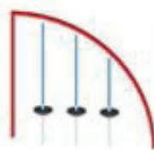

M-1



M-2

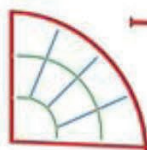

M-3

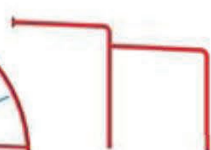

M-4



M-5



M-6



M-7

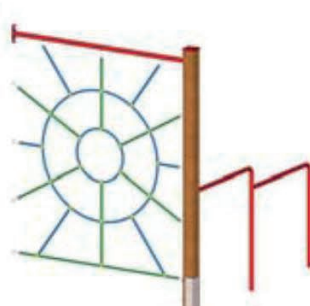

M-8



M-9





PM-1



PM-3

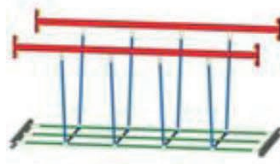

PM-6



PM-10

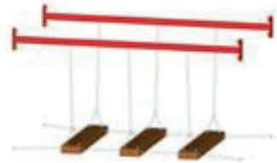

PM-16



PD-1



PD-5



PD-12

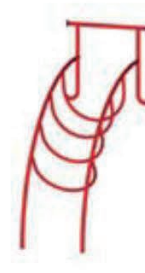

PD-11



PD-8

VSTUPY



PD-16



PD-9



PD-6



PD-4



PD-10



PD-7



PD-13



PD-14

ŠMYKĽAVKY



Z-1

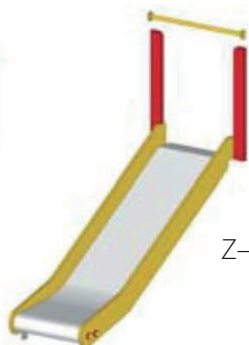

Z-4

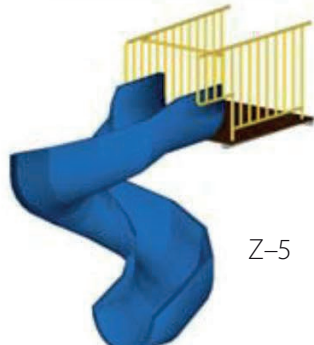

Z-5

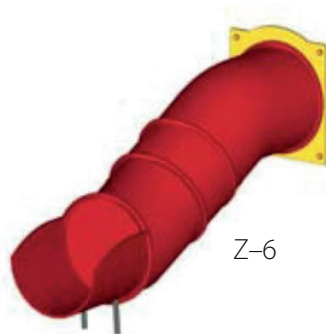

Z-6



Z-7



nr kat.N001



nr kat.N002

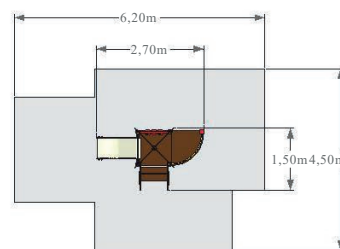

nr kat.N003



nr kat.N004

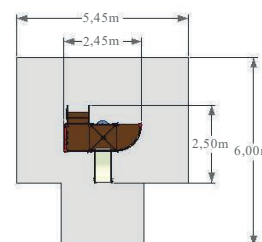



nr kat.N006

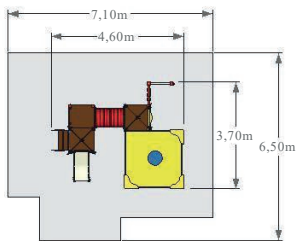

nr kat.N005



nr kat.N008

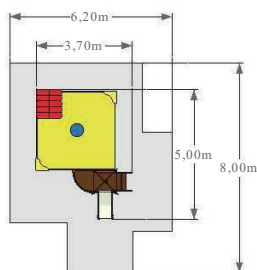

nr kat.N007

nr kat.N010

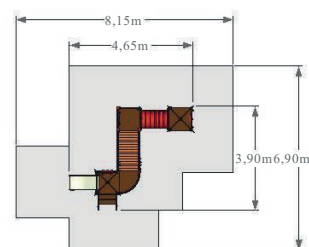

nr kat.N009



nr kat.N012

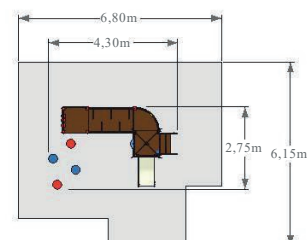

nr kat.N011



nr kat.N014

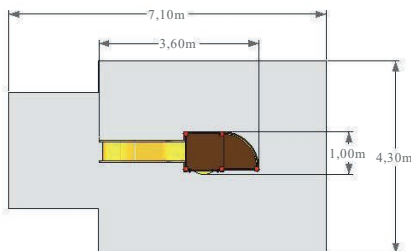
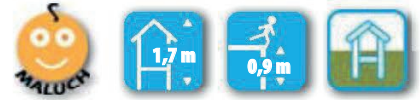

nr kat.N013



nr kat.N016

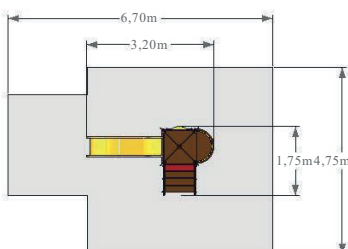

nr kat.N015



nr kat.N017



nr kat.N018

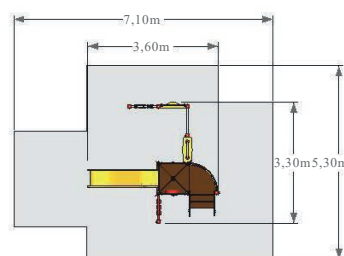

nr kat.N019



nr kat.N020

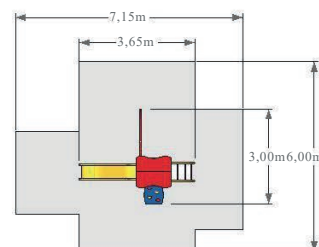



nr kat.N022

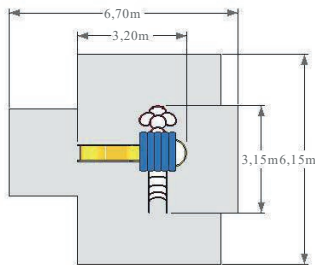

nr kat.N021



nr kat.N024

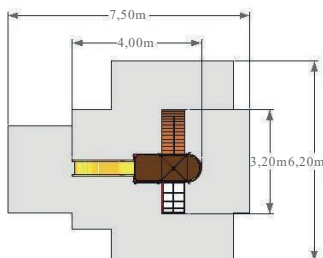

nr kat.N023





nr kat.N025

nr kat.N026

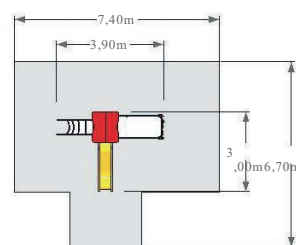

nr kat.N027



nr kat.N028

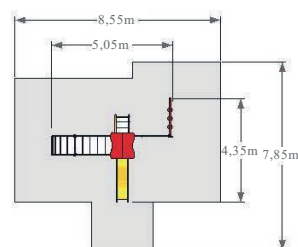



nr kat.N030

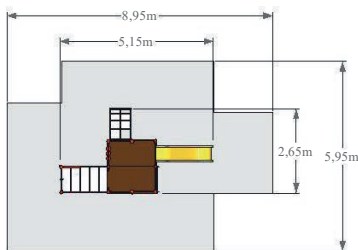

nr kat.N029



nr kat.N032

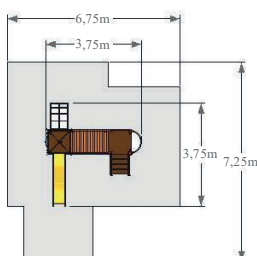

nr kat.N031

nr kat.N034



nr kat.N033

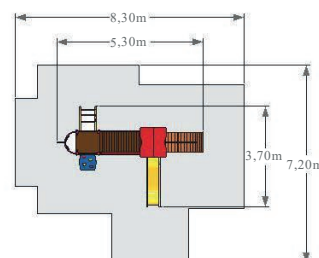

nr kat.N035



nr kat.N036

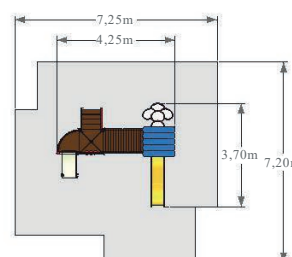

nr kat.N038

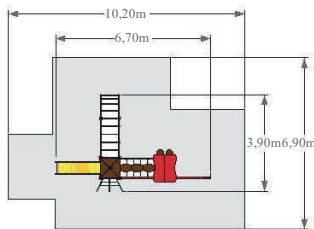

nr kat.N037



nr kat.N040

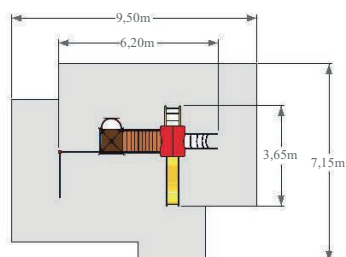

nr kat.N039



nr kat.N041



nr kat.N042

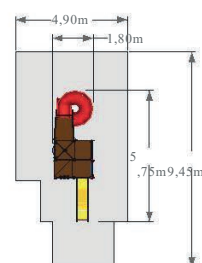

nr kat.N043



nr kat.N044

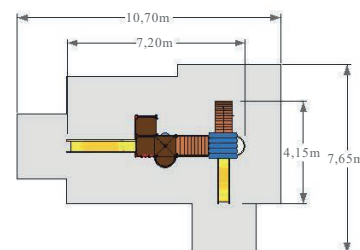

nr kat.N046

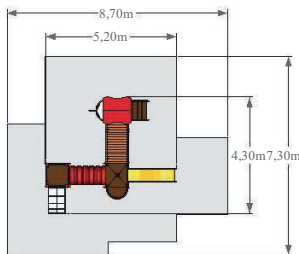

nr kat.N045



nr kat.N048

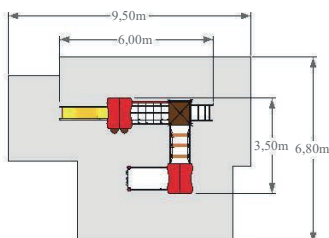

nr kat.N047



nr kat.N049



nr kat.N050

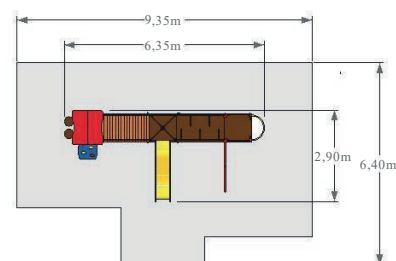

nr kat.N051



nr kat.N052

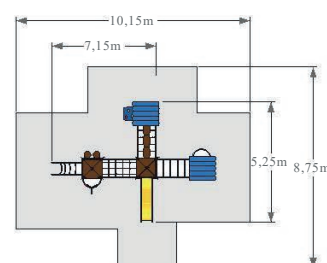

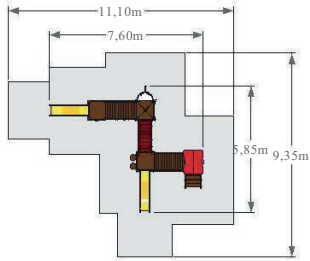

nr kat.N054



nr kat.N053



nr kat.N056

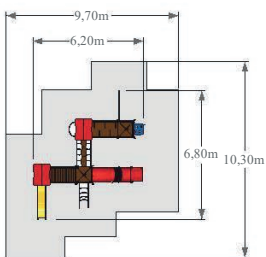

nr kat.N055

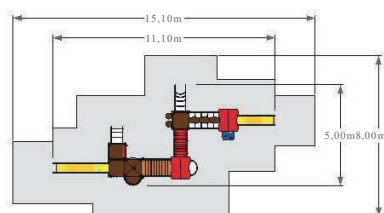

nr kat.N058



nr kat.N057



nr kat.N060

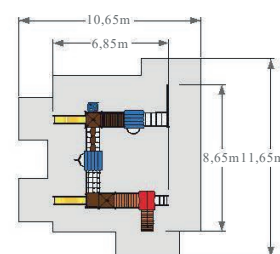

nr kat.N059

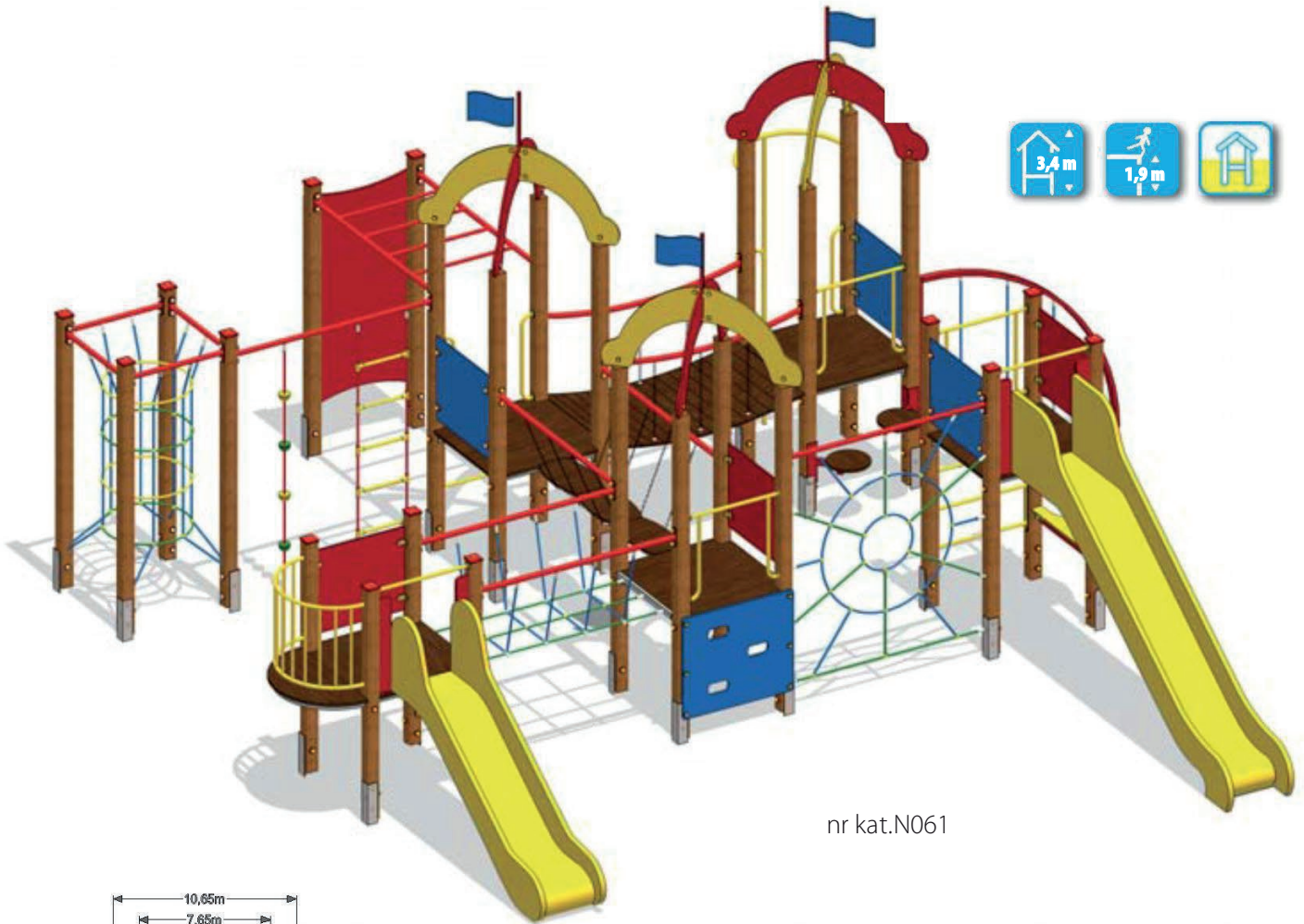

nr kat.N061

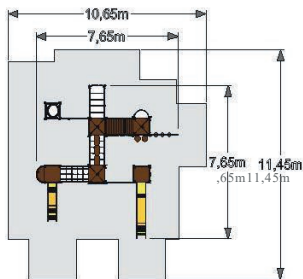

nr kat.N062



nr kat.N063

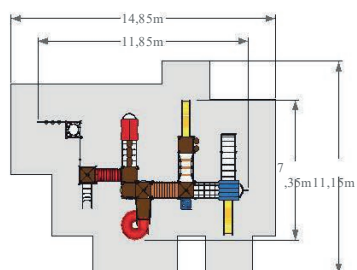

nr kat.N064



nr kat.N065



nr kat.N066

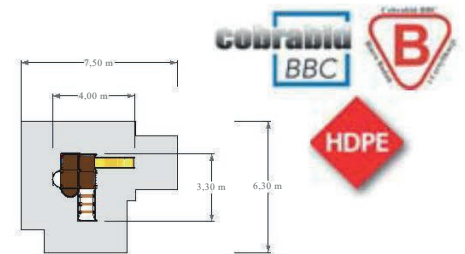

nr kat.N067



nr kat.N068

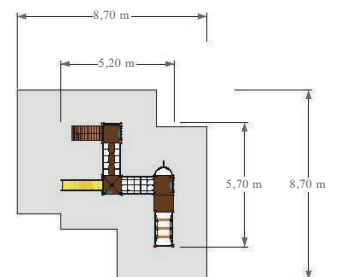

nr kat.N070

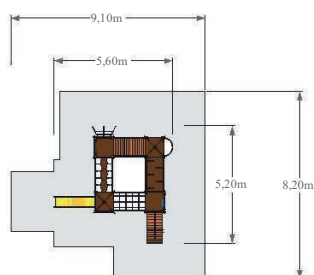

nr kat.N069

nr kat.N072

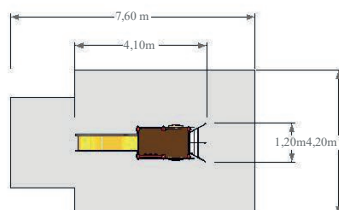

nr kat.N071



nr kat.N074



nr kat.N073

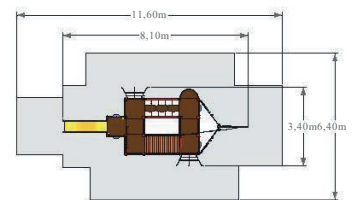

nr kat.N076



nr kat.N075

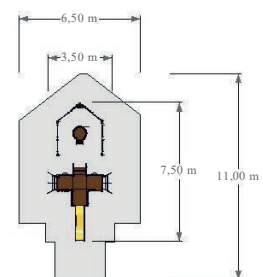

nr kat.N078



nr kat.N077

nr kat.N080



nr kat.N079



nr kat.N081

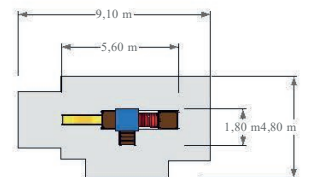

nr kat.N082



nr kat.N083

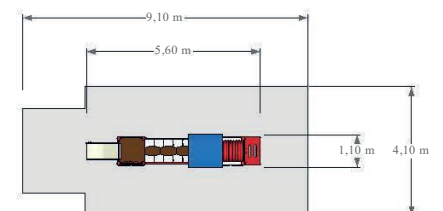

nr kat.N084





nr kat.N089

nr kat.N087

nr kat.N085



nr kat.N093

nr kat.N091



Vagón B
nr kat.N090

Vagón A
nr kat.N088

nr kat.N086

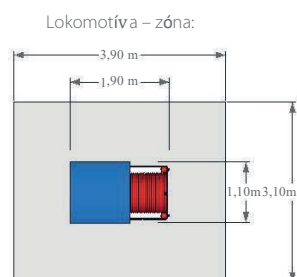

Vagón C
nr kat.N092

Vagón D
nr kat.N094

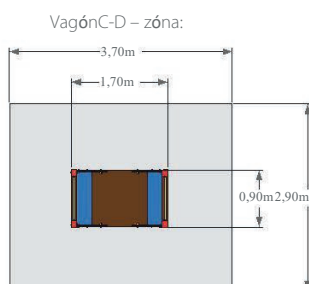
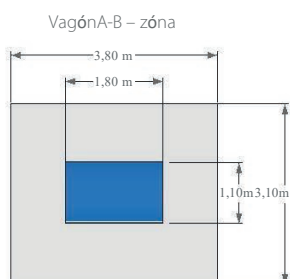

nr kat.N095

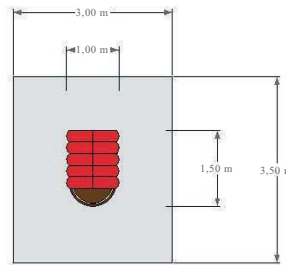

nr kat.N096



nr kat.N097

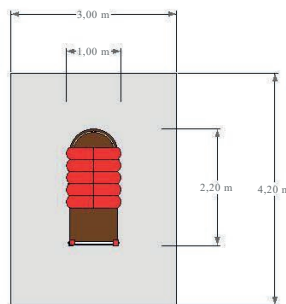

nr kat.N098



nr kat.N099

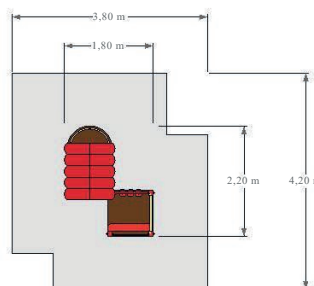

nr kat.N100



nr kat.N101

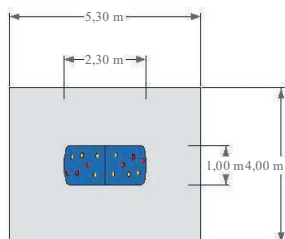

nr kat.N103

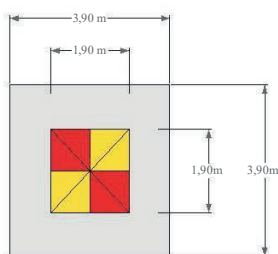

nr kat.N102

nr kat.N104



nr kat.N105

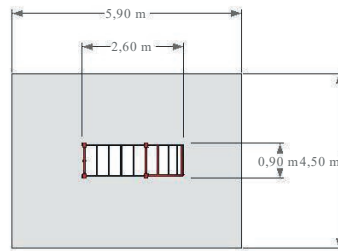

nr kat.N106



nr kat.N107

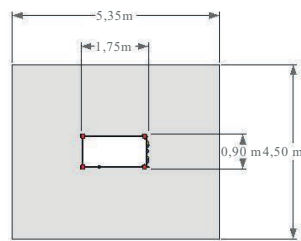

nr kat.N108



nr kat.N109

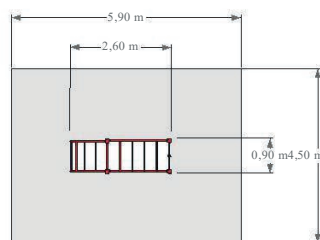



nr kat.N110

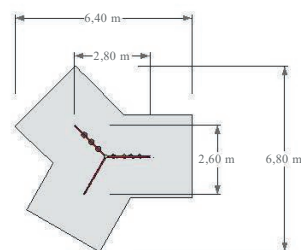

nr kat.N111



nr kat.N112

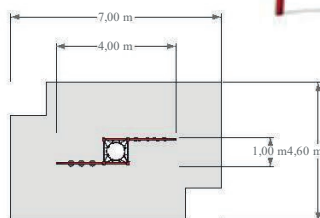

nr kat.N113



nr kat.N114

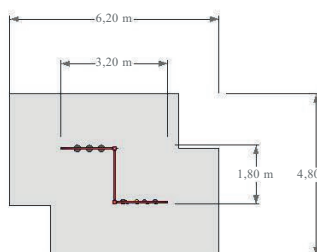

nr kat.N115

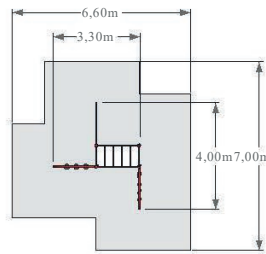

nr kat.N116



nr kat.N117

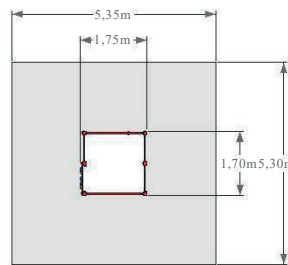

nr kat.N118



nr kat.N119

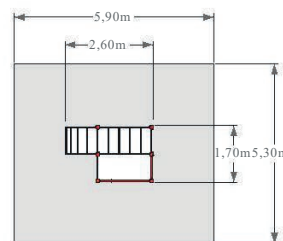

nr kat.N120



nr kat.N121



nr kat.N122

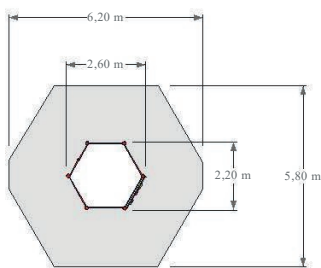

nr kat.N123



nr kat.N124

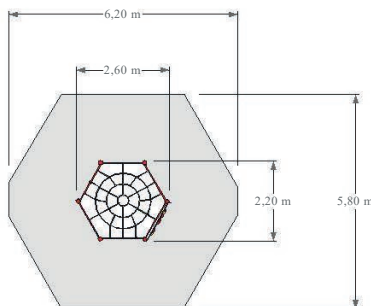

nr kat.N125

nr kat.N126

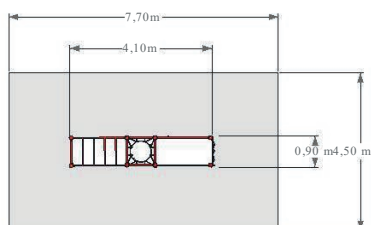
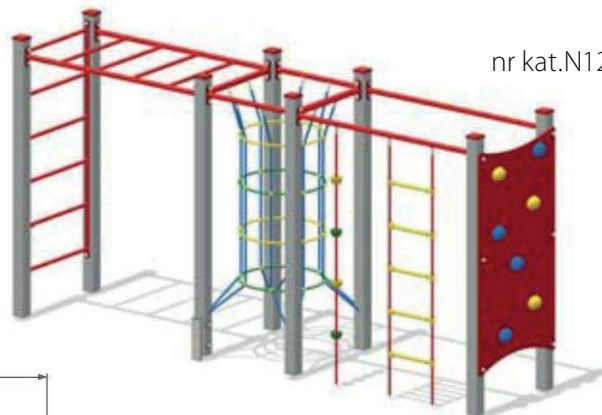
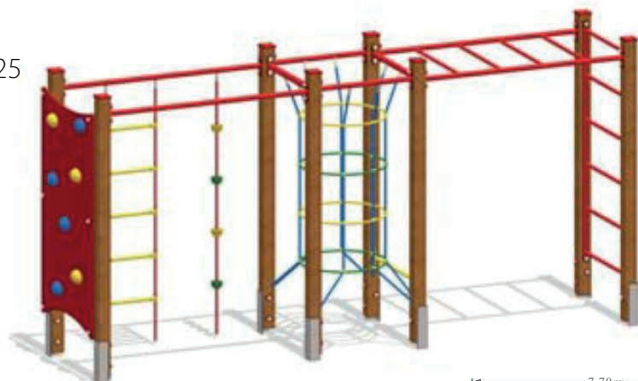

nr kat.N127

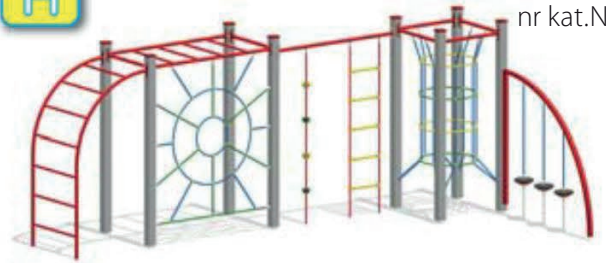
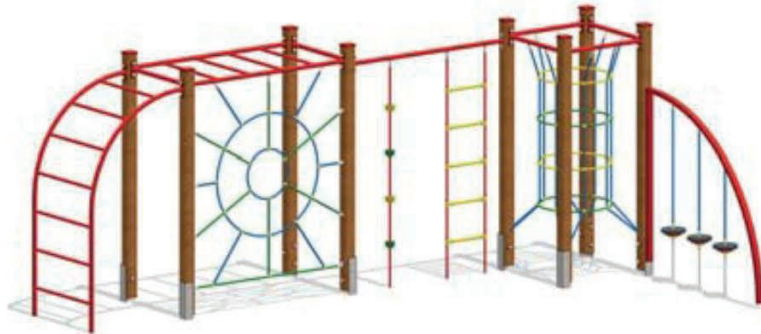

nr kat.N128

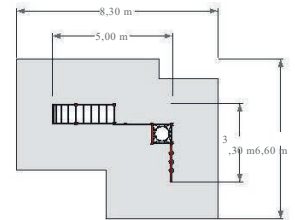

nr kat.N129

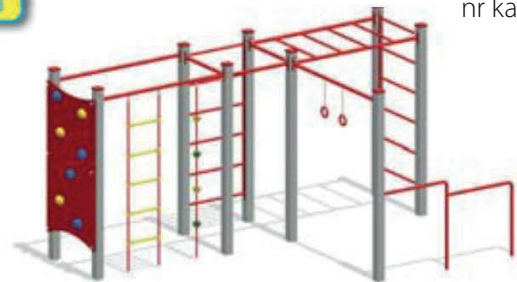
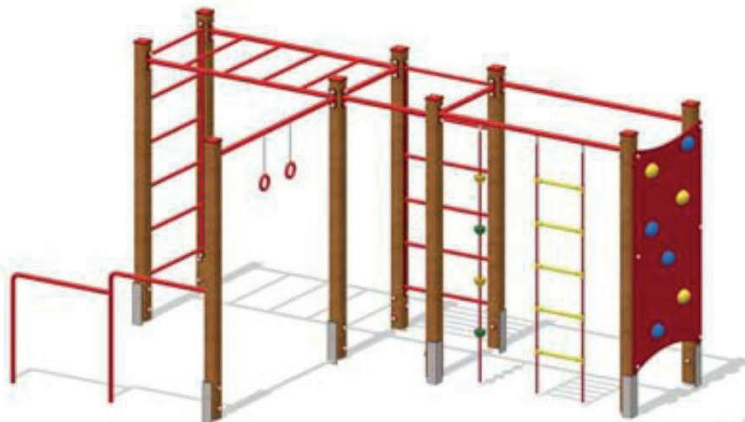

nr kat.N130

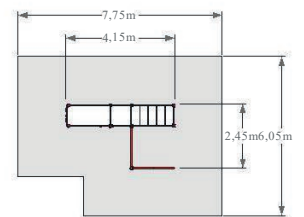

nr kat.N131

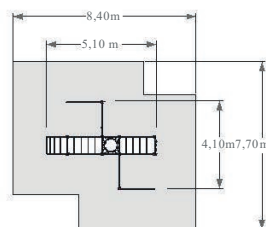

nr kat.N132





nr kat.N134

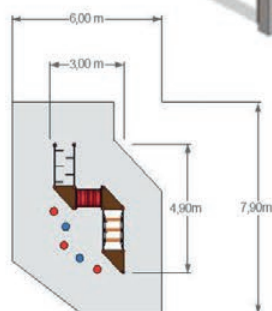

nr kat.N133

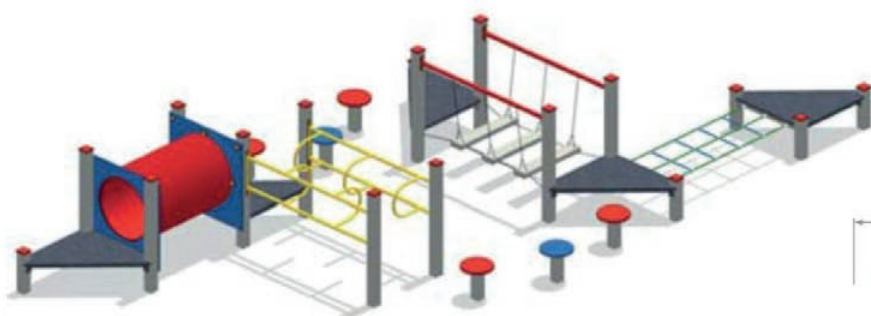

nr kat.N136

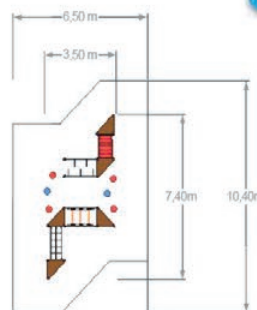

nr kat.N135



nr kat.N137

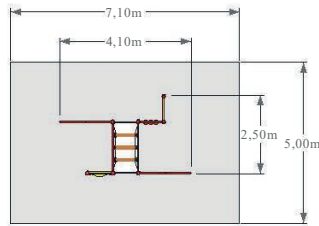
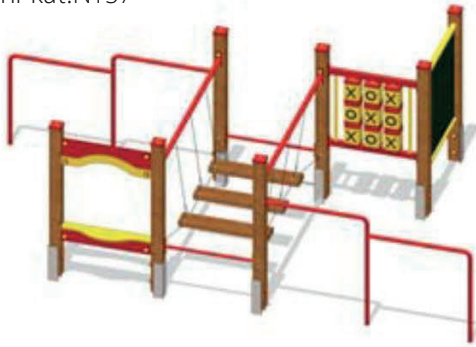

nr kat.N138



nr kat.N139

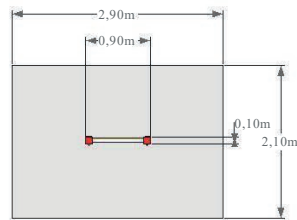
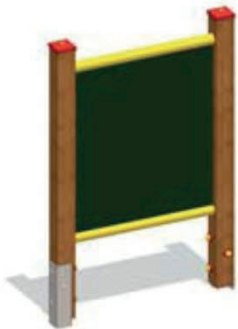

nr kat.N140

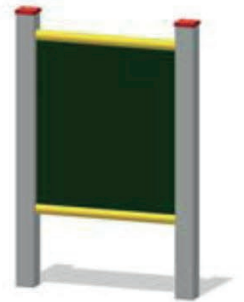

nr kat.N141

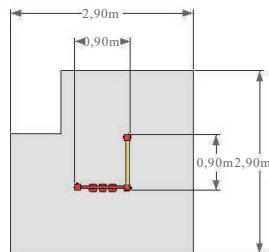

nr kat.N142



nr kat.N143

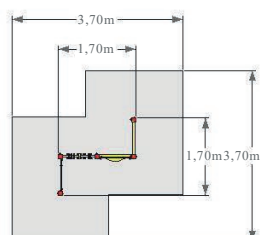

nr kat.N144



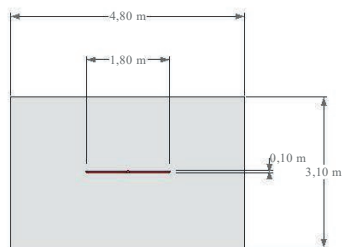

nr kat.N145

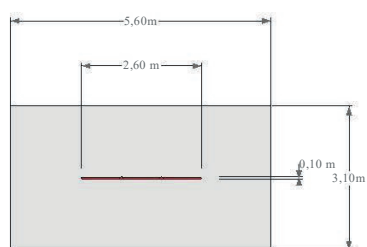

nr kat.N146

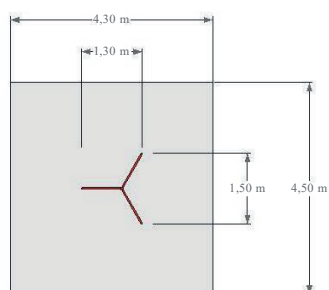

nr kat.N147

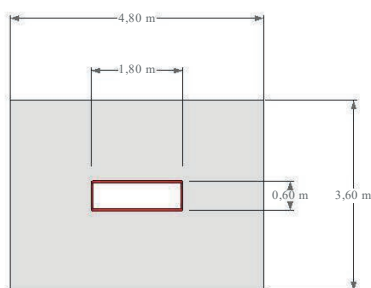

nr kat.N148



nr kat.N149

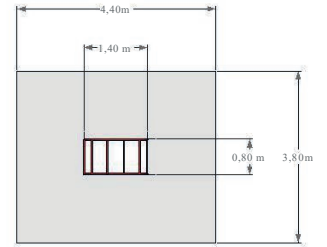

nr kat.N150

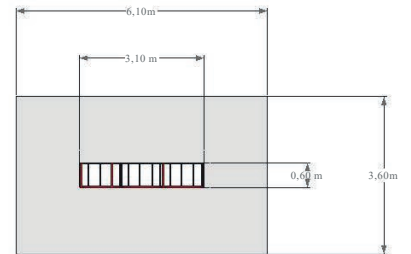

nr kat.N151

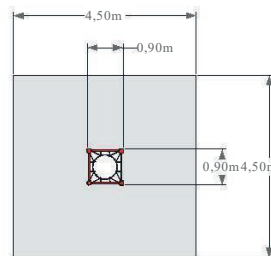

nr kat.N152

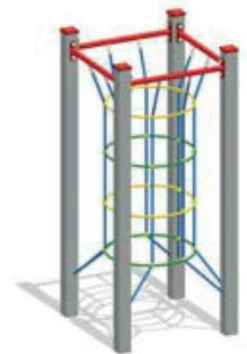

nr kat.N153

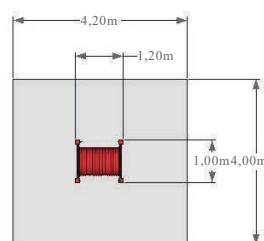
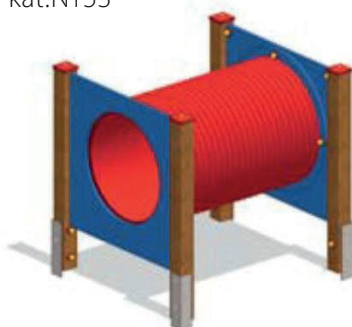

nr kat.N154

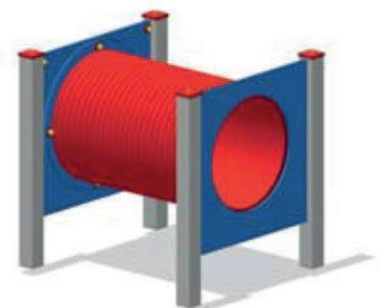

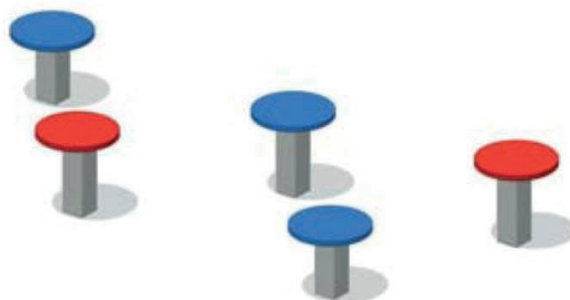
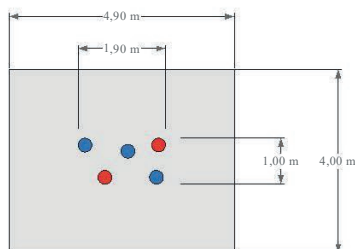

nr.kat.N155

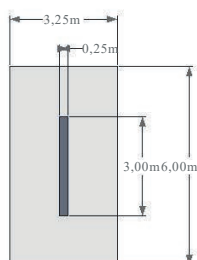

nr.kat.N156

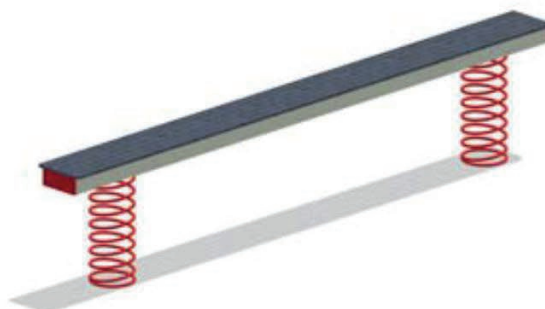
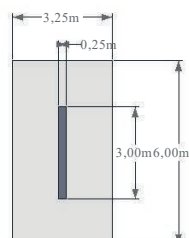

nr.kat.N157

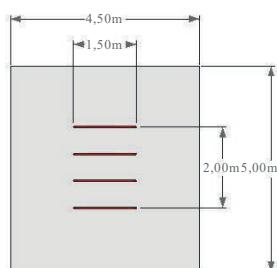

nr.kat.N158



nr kat.N159

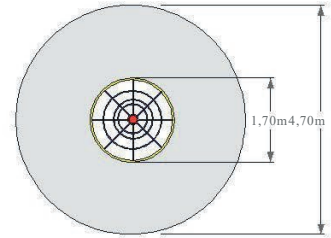

nr kat.N160

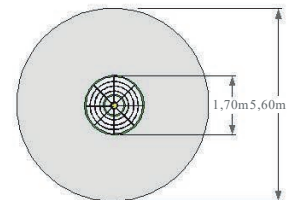
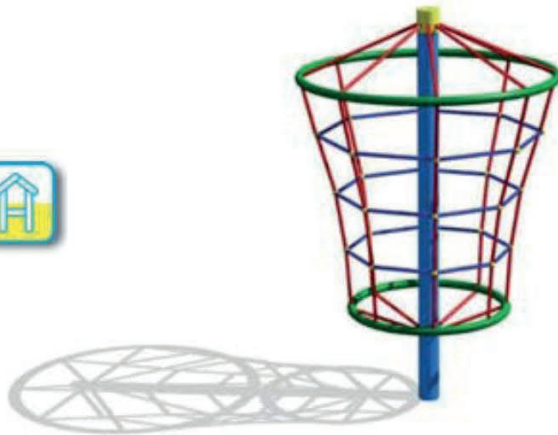

nr kat.N161

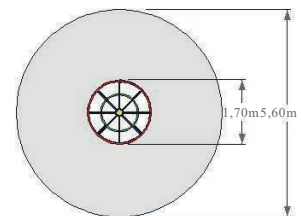
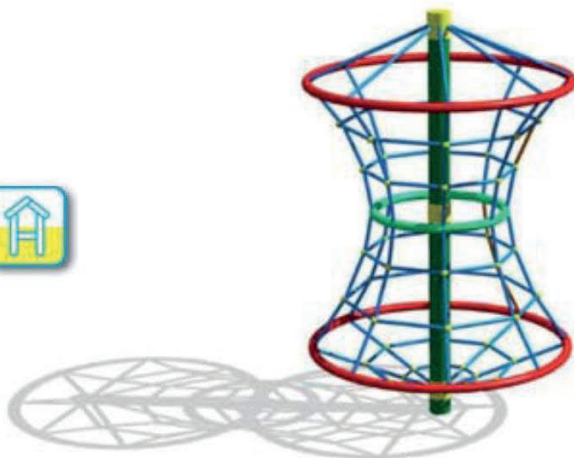

nr kat.N162

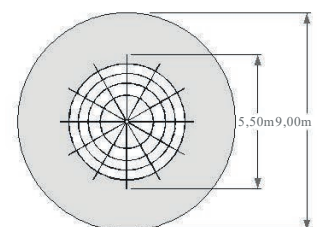
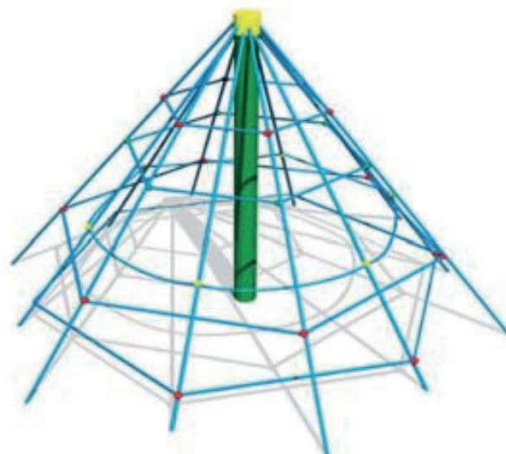



nr kat.N163

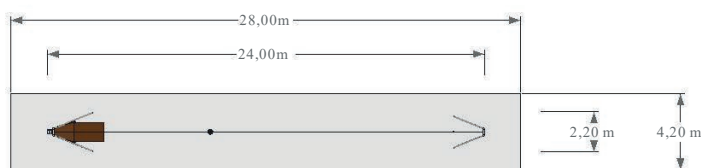

nr kat.N164

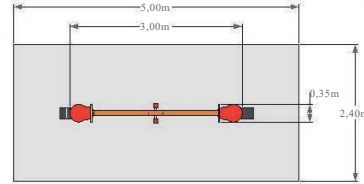

nr kat.N165

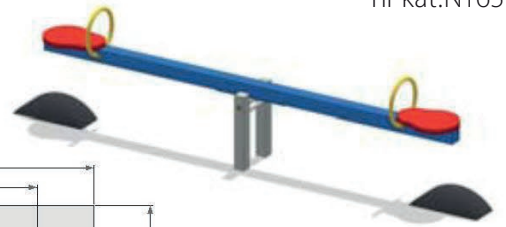

nr kat.N166

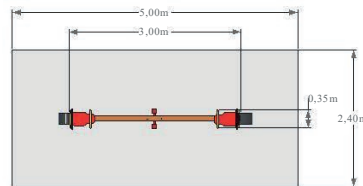

nr kat.N167



nr kat.N168

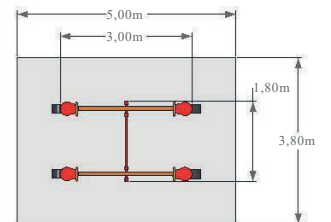
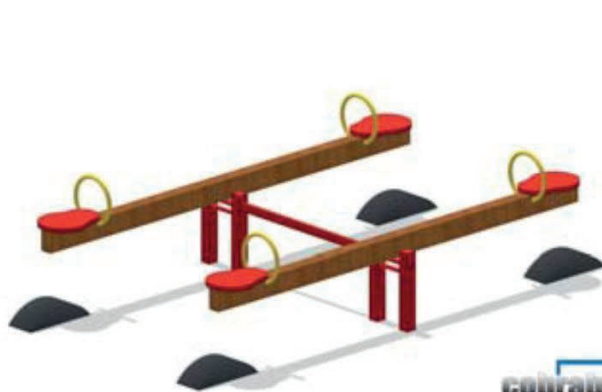

nr kat.N169

nr kat.N170

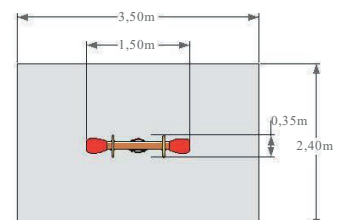
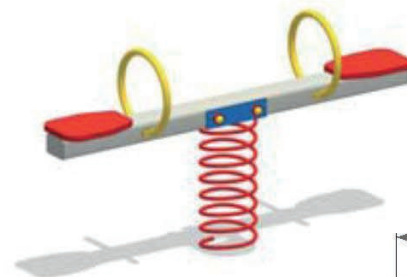

nr kat.N171

nr kat.N173

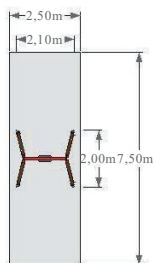

nr kat.N172



nr kat.N175

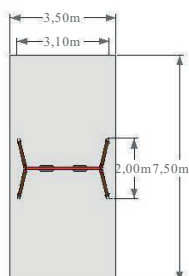

nr kat.N174



nr kat.N177

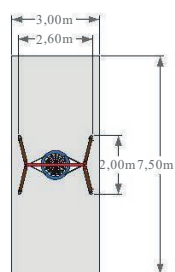

nr kat.N176



nr kat.N178



nr kat.N179



nr kat.N180

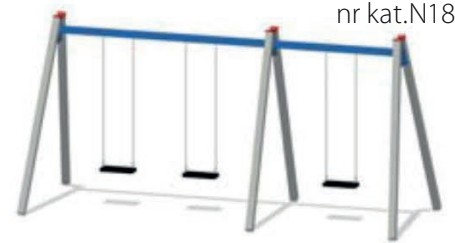

nr kat.N181

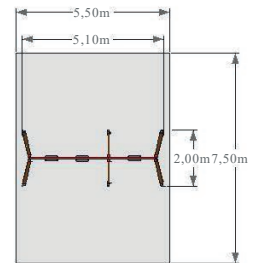

nr kat.N182



nr kat.N183

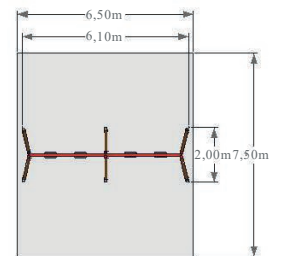

nr kat.N184



nr kat.N185

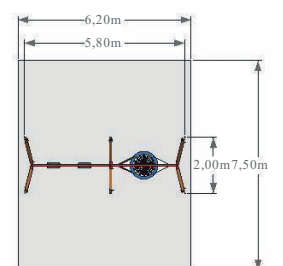

nr kat.N186

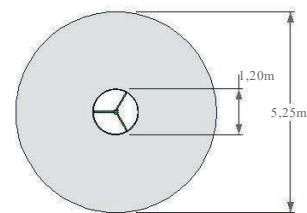

nr kat.N187

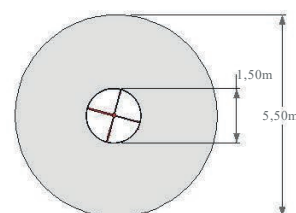
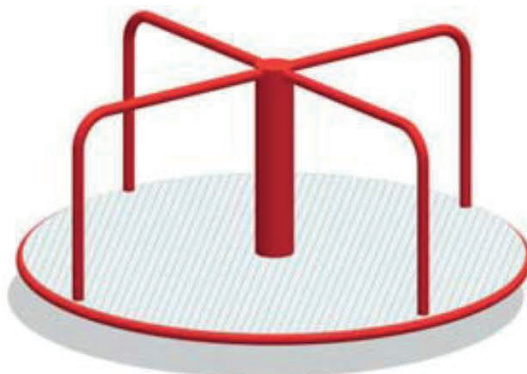

nr kat.N188

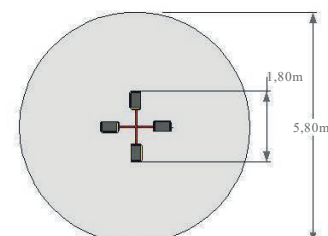
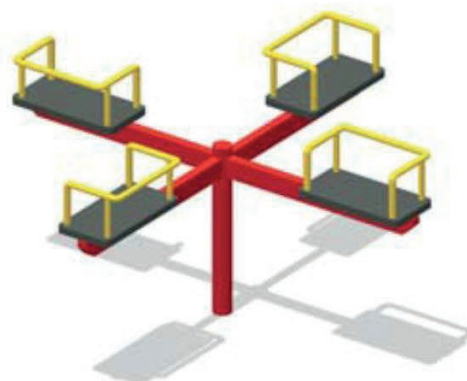

nr kat.N189

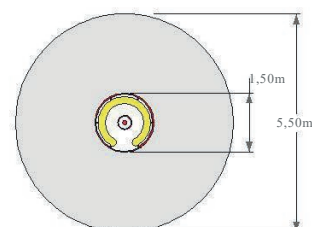

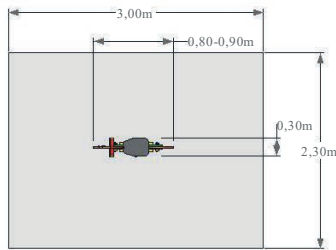

nr kat.N190



nr kat.N191



nr kat.N192

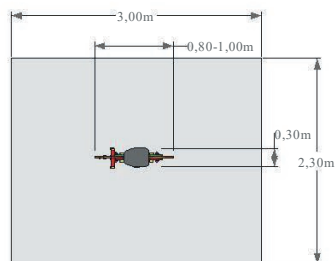

nr kat.N193



nr kat.N194



nr kat.N195



nr kat.N196



nr kat.N197



nr kat.N198



nr kat.N199



nr kat.N200



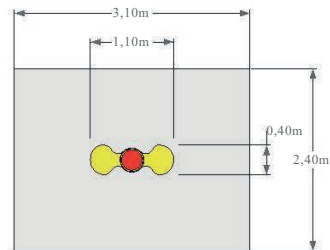
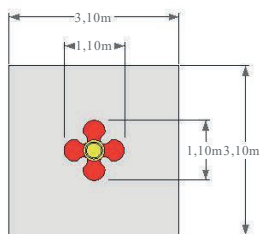
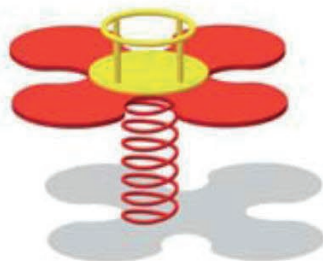
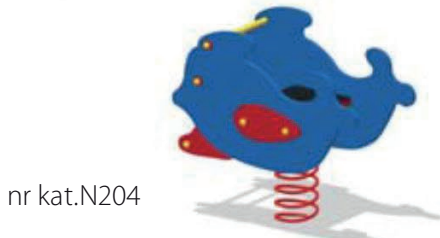
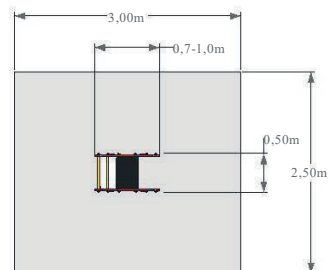

nr kat.N208

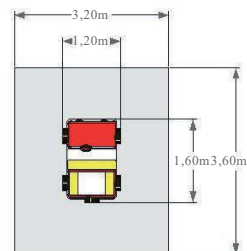
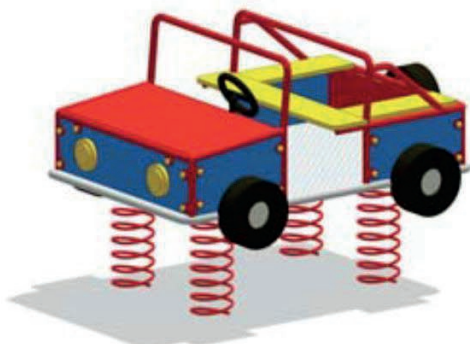

nr kat.N210



nr kat.N209

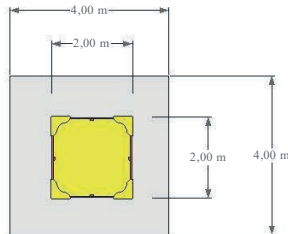
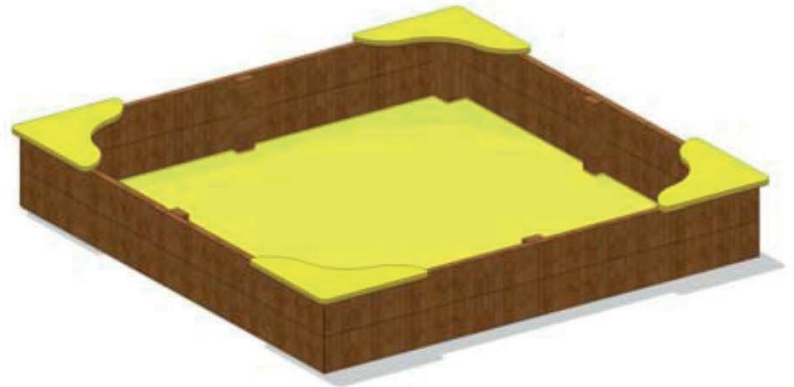

nr kat.N212



nr kat.N211

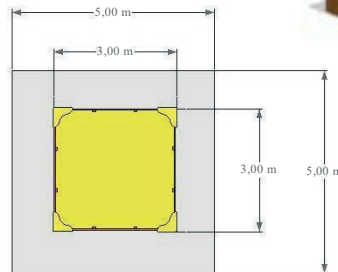
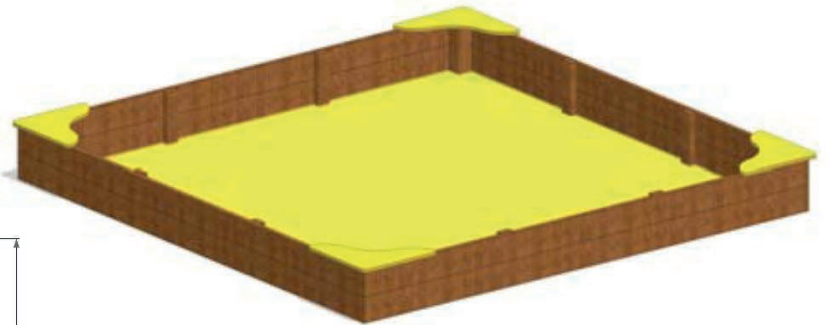
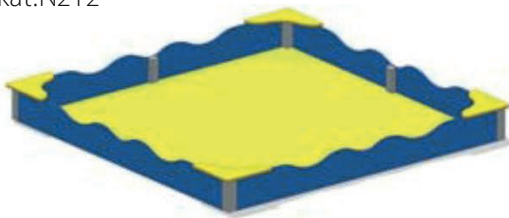

nr kat.N214



nr kat.N213

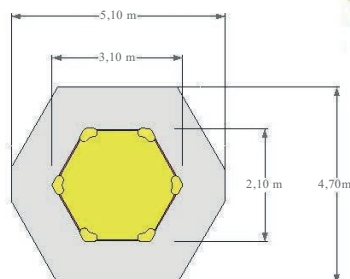
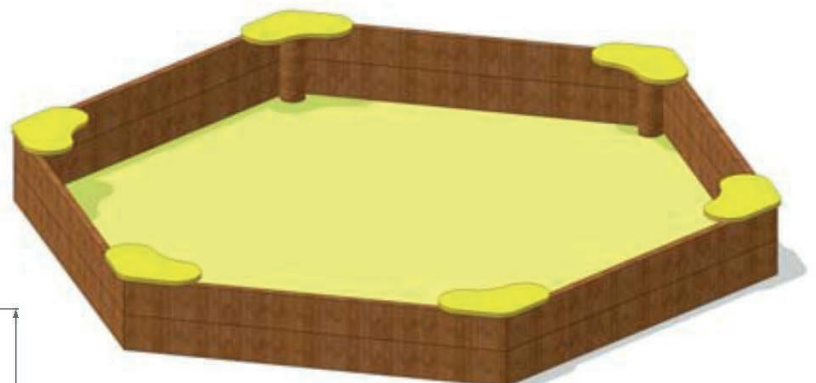
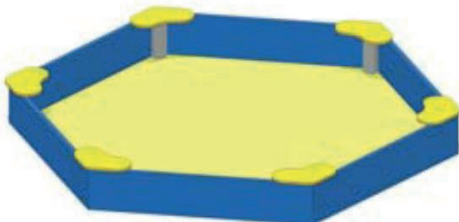

nr kat.N215



nr kat.N216

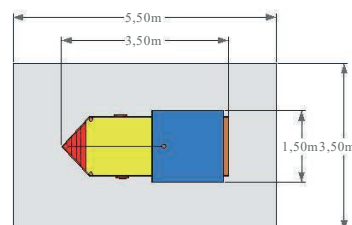

nr kat.N217

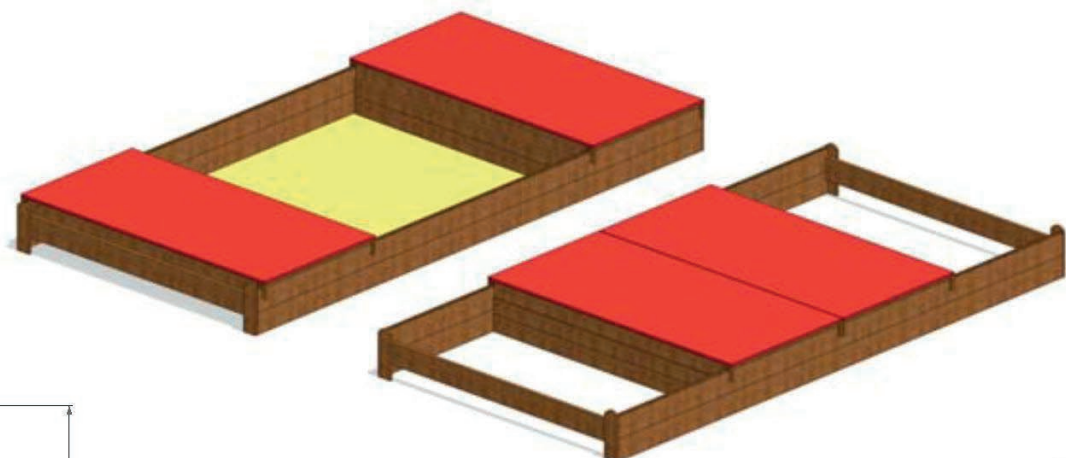
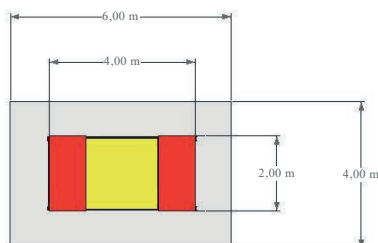

2x2 m

nr kat.N218



3x3 m

nr kat.N219



nr kat.N220



Orbitrek
nr kat.N221

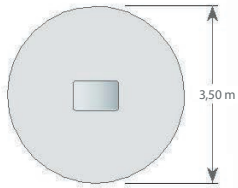

Bežec
nr kat.N222

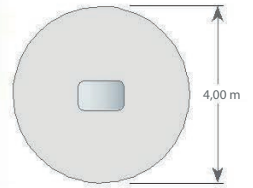

Stepper
nr kat.N223

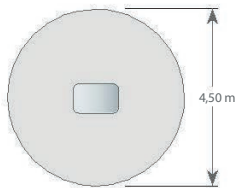

Jazdec
nr kat.N224

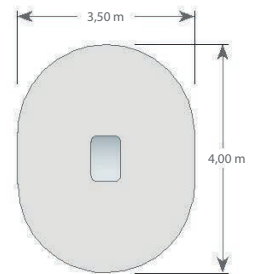

Výťah horný
nr kat.N225

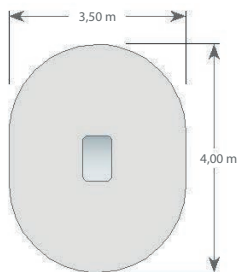

Bicykel
nr kat.N226

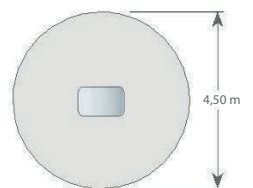

Veslár
nr kat.N227

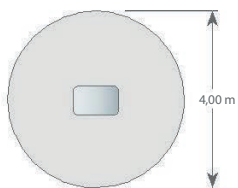

Bradlá
nr kat.N228

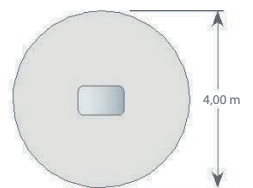

Ručný tlak
nr kat.N229

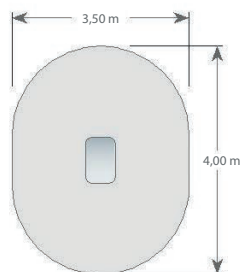

Nožný tlak
nr kat.N230

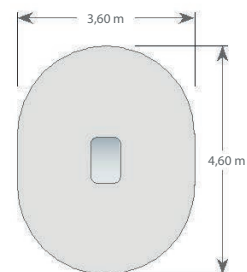

Dvojité kyvadlo
nr kat.N231

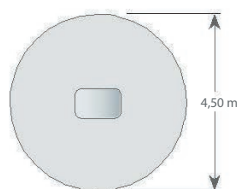

Dvojitý lyžiar
nr kat.N232

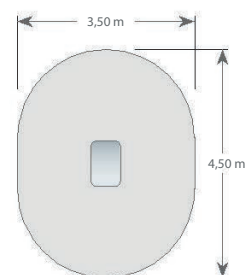

**Príťahovač-
odťahovač
dvojitý**
nr kat.N233

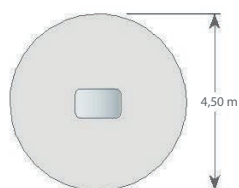

**Pylon / Tabuľka
informačná**
nr kat.N234



Motýľ AB
nr kat.N235

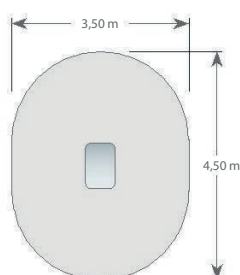

StreetWorkout

nr kat.N236

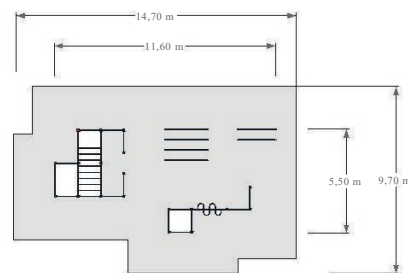

StreetWorkout1

nr kat.N237

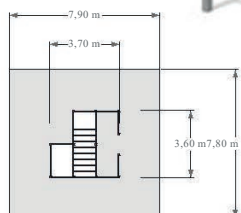

StreetWorkout2

nr kat.N238

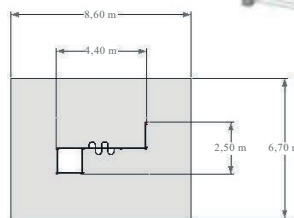
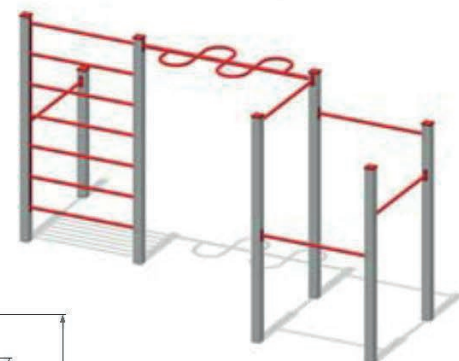

StreetWorkout3

nr kat.N239

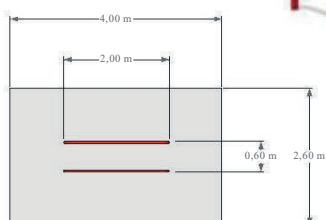

StreetWorkout4

nr kat.N240

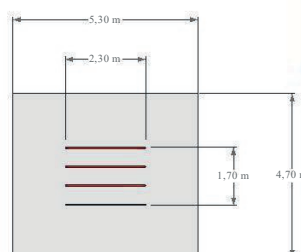

nr kat.N241

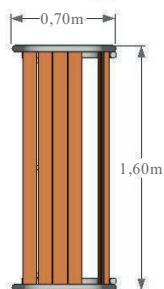

nr kat.N242

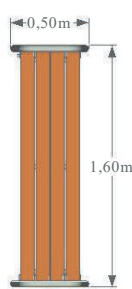

nr kat.N243

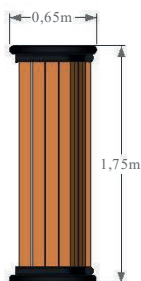

nr kat.N244

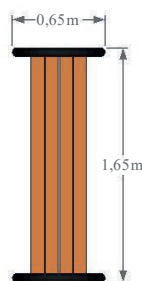

nr kat.N245

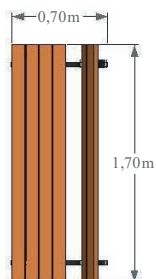

nr kat.N246

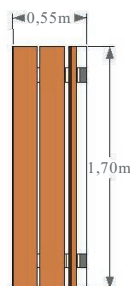

nr kat.N247

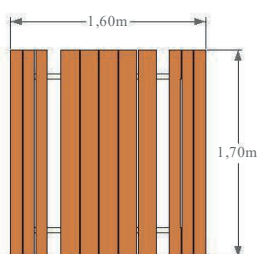

nr kat.N248

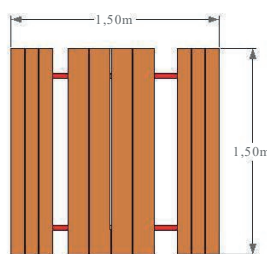

nr kat.N249



nr kat.N250

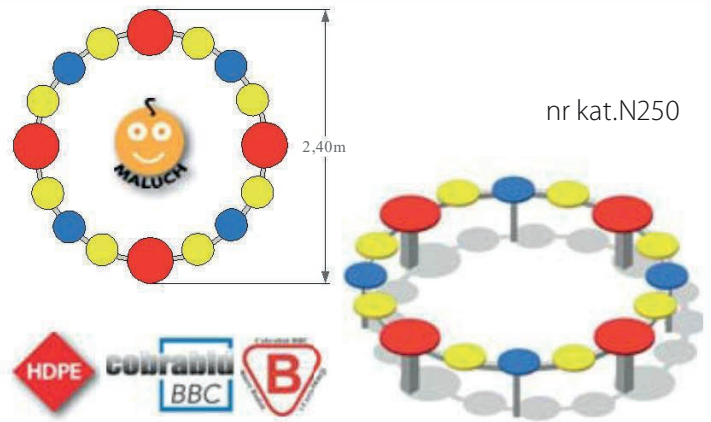

nr kat.N251

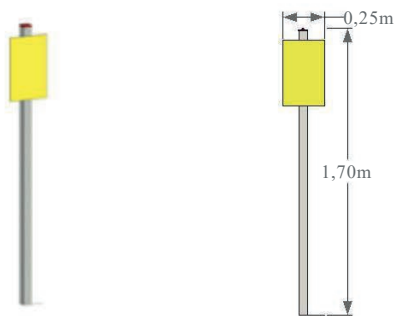

nr kat.N252

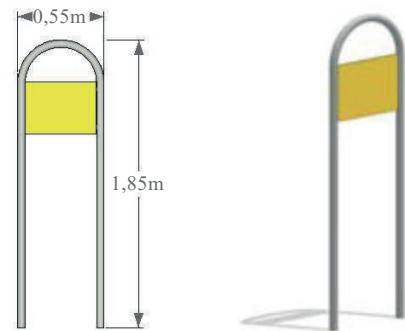

A4

nr kat.N253



A3

nr kat.N254



Stojan

nr kat.N255



nr kat.N256

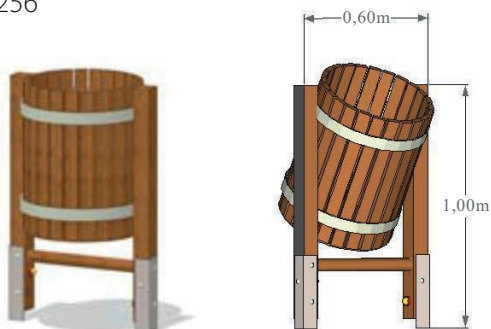

nr kat.N257

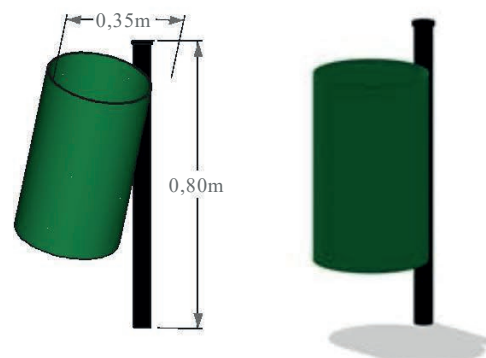

nr kat.N258

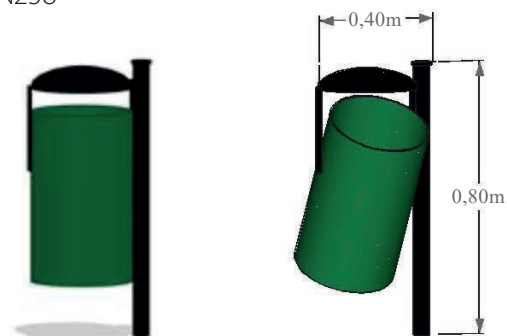

nr kat.N259

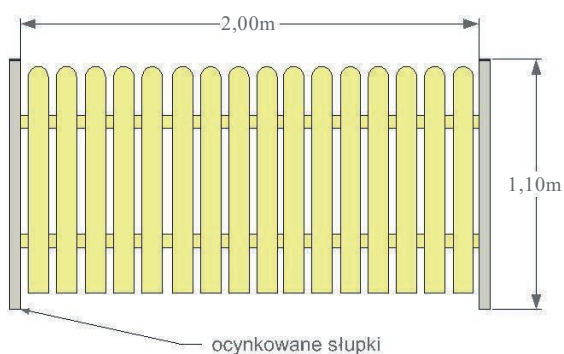

 Drevo impregnované a maľované
nrkat.N260





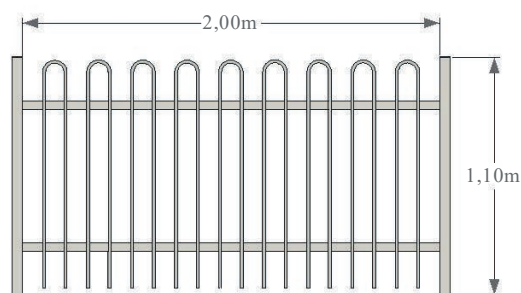

 Drevo impregnované tlakovo
nrkat.N261



 Zinkované
nrkat.N262



  Pozinkované maľové
nrkat.N263
  Dostupné farebné možnosti podľa palety RAL (za doplatok)

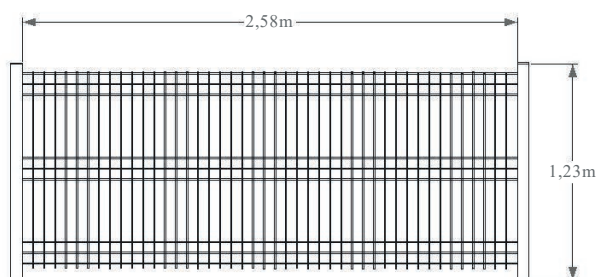

 Zinkované
nrkat.N264



  Zinkované a maľované
nrkat.N265
  Dostupné farebné možnosti podľa palety RAL (za doplatok)

Dostupné výšky:
1,03m; 1,23m; 1,53m; 1,73m; 1,93m; 2,03m

SPORTESA

pod' sa hrat'...

